

# °caleon

Installation and operating instruction

°CALEON Thermostat

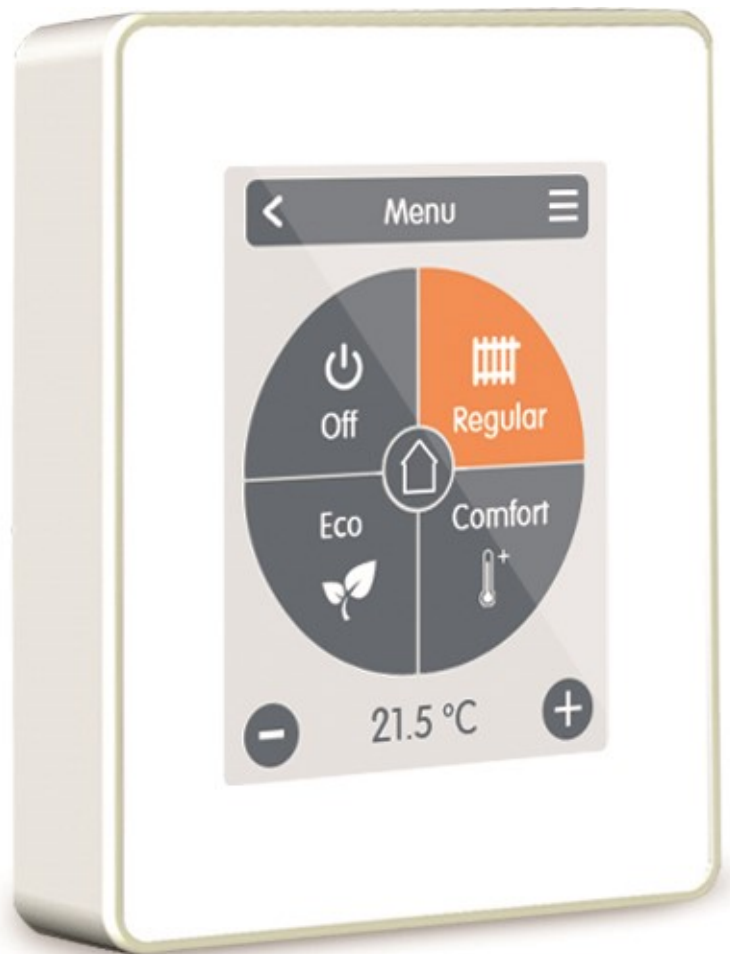

Read carefully before installation, commissioning and operation

# Content

<b>Safety Instructions</b> .....	<b>3</b>
EG-Conformity .....	3
General instructions .....	3
Changes to the Unit .....	3
Warranty and Liability .....	3
Disposal and Pollutants .....	3
<b>Description °CALEON Thermostat</b> .....	<b>4</b>
Specifications .....	4
Scope of supply .....	4
<b>Installation</b> .....	<b>5</b>
°CALEON Installation .....	5
Sample wiring .....	6
<b>Setup</b> .....	<b>6</b>
Setup procedure .....	6
<b>Operation</b> .....	<b>7</b>
Overview of temperatures & humidity .....	7
Select Operating Mode .....	7
Main Menu .....	7
Expert Menu .....	8
Expert Menu Settings .....	8
Settings Functions .....	9
Set Operation Hours .....	10
Set Operation Hours .....	10

# SAFETY INSTRUCTIONS

## EG-Conformity

By affixing the CE mark to the unit the manufacturer declares that °CALEON Thermostat conforms to the following relevant safety regulations:

- EU low voltage directive 2014/35/EU
- EU electromagnetic compatibility directive 2014/30/EU

conforms. Conformity has been verified and the corresponding documentation and the EU declaration of conformity are kept on file by the manufacturer.

## General instructions

### Please read carefully!

These installation and operating instructions contain basic instructions and important information regarding safety, installation, commissioning, maintenance and the optimal use of the unit. Therefore these instructions must be read and understood completely by the installation technician/specialist and by the system user before installation, commissioning and operation of the unit.

This unit is an automatic, electrical °CALEON Roomthermostat. Install the device only in dry rooms and under environmental conditions as described under "Technical Data".

In addition, observe the applicable accident prevention regulations, the regulations of the Association of Electrical Engineering, the local power supply utility, the applicable DIN-EN standards and the installation and operating instructions for the additional system components. Installation, electrical connection, commissioning and maintenance of the unit may only be carried out by specialists who possess the appropriate training.

**Users: Make sure that the specialist gives you detailed information on the function and operation of the unit. Always keep these instructions in the vicinity of the unit.**

The manufacturer does not take over any liability for damage caused through improper usage or non-compliance of this manual!

## Changes to the Unit

- Changes, additions to or conversion of the unit are not permitted without written permission from the manufacturer.
- It is likewise forbidden to install additional components that have not been tested together with the unit.
- If it becomes clear that safe operation of the unit is no longer possible, for example because of damage to the housing, turn the Unit off immediately.
- Any parts of the unit or accessories that are not in perfect condition must be exchanged immediately.
- Use only original spare parts and accessories from the manufacturer.
- Markings made on the unit at the factory must not be altered, removed or made illegible.
- Only the settings described in these instructions may be set using the Unit.



Changes to the unit can compromise the safety and function of the unit or the entire system.

## Warranty and Liability

The Unit has been manufactured and tested with regard to high quality and safety requirements. The warranty and liability shall not include, however, any injury to persons or material damage that is attributable to one or more of the following causes:

- Failure to observe these installation and operating instructions.
- Improper installation, commissioning, maintenance and operation.
- Improperly executed repairs.
- Unauthorized structural changes to the unit.
- Use of the device for other than its intended purpose.
- Operation above or below the limit values listed in the 'Specifications' section.
- Force majeure.

## Disposal and Pollutants

The unit conforms to the European RoHS 2011/65/EU for the restriction of the use of certain hazardous substances in electrical and electronic equipment.







Under no circumstances may the device be disposed of with the normal household waste. Dispose of the unit only at appropriate collection points or ship it back to the seller or manufacturer.

# DESCRIPTION °CALEON THERMOSTAT

## Specifications



	Housing	2-part, ABS plastic 75 mm x 95 mm x 30 mm Glass front
	Display	Capacitive touch panel Color display with 240x320 dots 2.8 inches (7 cm) diagonal
	Operation	Intuitive user guidance
	Language	Deutsch English Español Italiano Français Português

### Electrical specifications:

Power supply	100 - 240 VAC, 50 - 60 Hz
Power consumption	max. 2,5 W
Protection category	IP20
Protection class / overvoltage category	0/III

### Max. cable length

1-Wire Bus	Optional, without function
------------	----------------------------

### Permissible Ambient Conditions

during operation	0 °C - 50 °C, no moisture condensation permitted
for transport/storage	0 °C - 60 °C, no moisture condensation permitted

### Measuring range

Outside the measuring ranges there are larger deviations	
Internal temperature sensor	0 °C - 60 °C      Accuracy +/- 1 °C Resolution 0,1 °C
Internal sensor for rel. humidity	0 % - 100 %      Accuracy +/- 6 °C Resolution 0,1 %
1-Wire temperature sensors	Optional, without function

### Other Specifications

Installation methods	Wall installation, with/without wall socket
Real Time Clock	RTC with 24 hour power reserve

## Scope of supply

- °CALEON Roomthermostat
- 2 screws 3,5 x 35 mm and 2 plugs 6 mm for wall installation.
- °CALEON Thermostat installation guide

# INSTALLATION

## °CALEON Installation

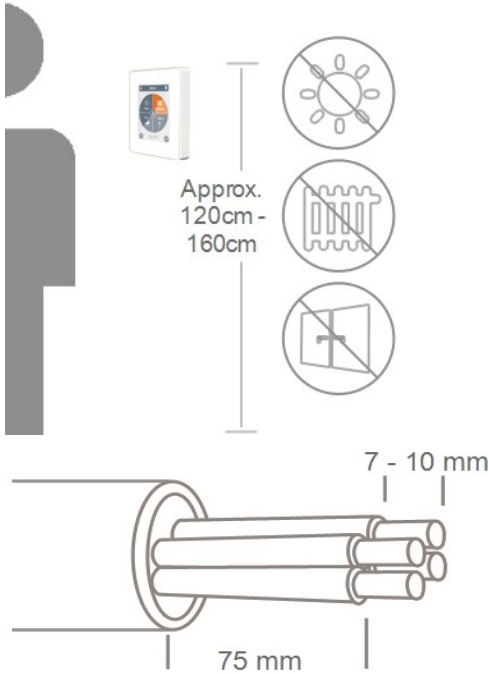

Mount the unit at a suitable location.

 Pay attention to suitable environmental conditions. Direct sunlight, sources of heat and cold, e.g. radiators and windows must be avoided.

Strip cables by 75 mm max. and strip the last 7-10 mm of the wires.

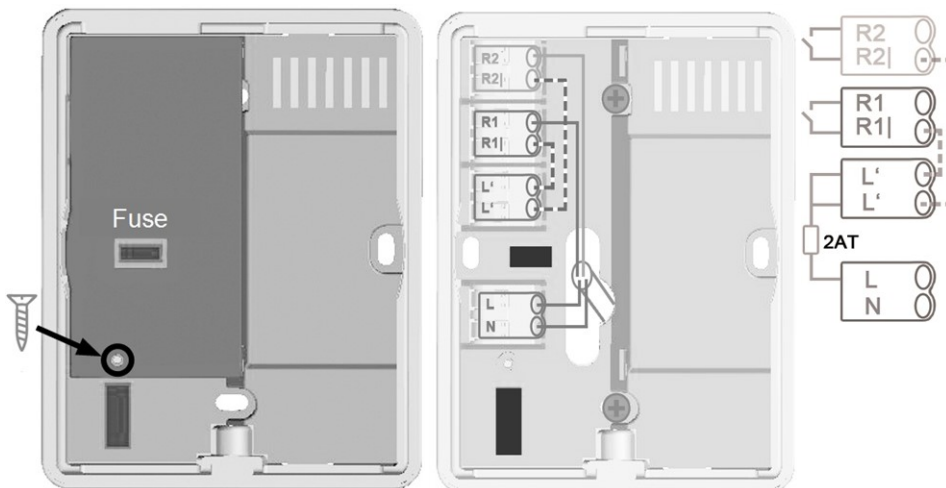

Unscrew the screw, remove the cable cover and connect the electric as described.

 Only mains voltage, no SELV!

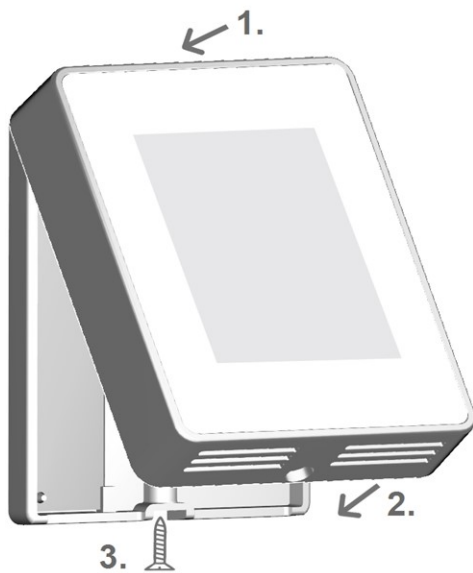

Refit the base and fasten with screw. Switch on mains voltage and place °CALEON in operation.

 The commissioning can be accessed in the °CALEON menu under Expert at any time.

## Sample wiring

---

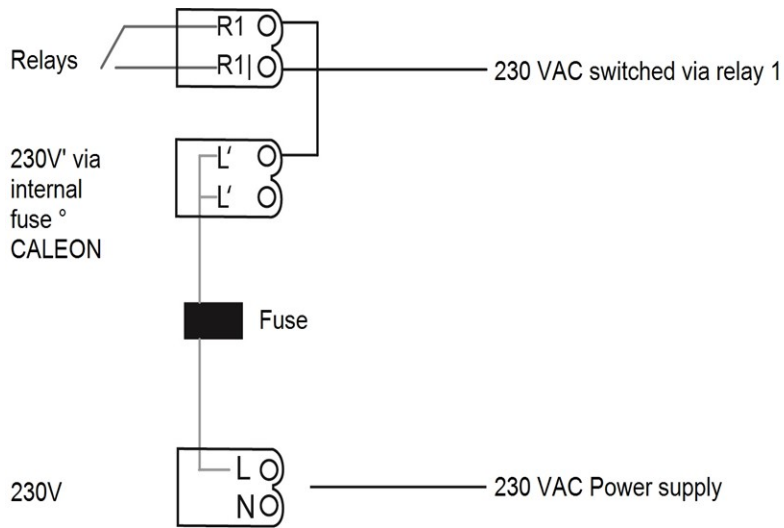

## SETUP

### Setup procedure

---

#### Install device

Install the device as described (see "Sample wiring" on page 6).



#### Set Functions

Assign a switching output to the respective function via the "Expert" menu in the "Settings" menu item under "Functions" and parameterize it (see "Settings Functions" on page 9).

## Overview of temperatures & humidity

It displays room temperature and humidity. If there is no activity for 60 sec., the device is automatically switched to the overview.



### Room temperature

Indicates the temperature of the selected Space in 0.1 degree increments.

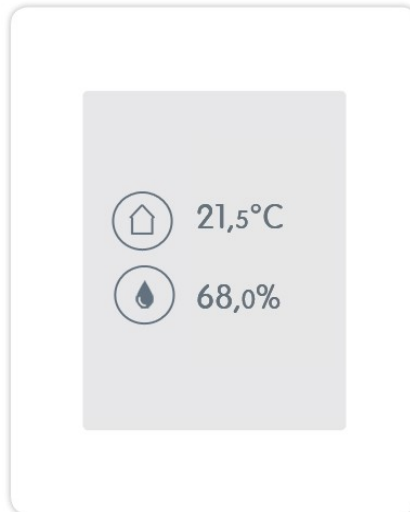

### Room humidity

Is the relative humidity of The selected space in 0.1 degree increments.

## Select Operating Mode



### Back

Navigate back to the overview.



### Location/Room

Displays the selected location/room.



### Minus/Plus

Change the target temperature +/- 0.5 ° C.

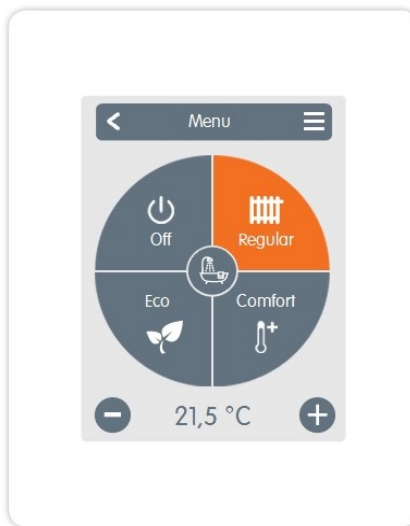

### Main menu

Navigate to the main menu



### Operating modes

Specifies which operating mode (Normal, Comfort, Eco and Off) is selected. The selected mode is shown in color. By pressing the plus and minus keys it is possible to adjust the setpoint temperature of the modes.

## Main Menu

Overview > Operating Mode > Main Menu



### Periods

Adjustment of individual heating times for each weekday with copy function for subsequent days.

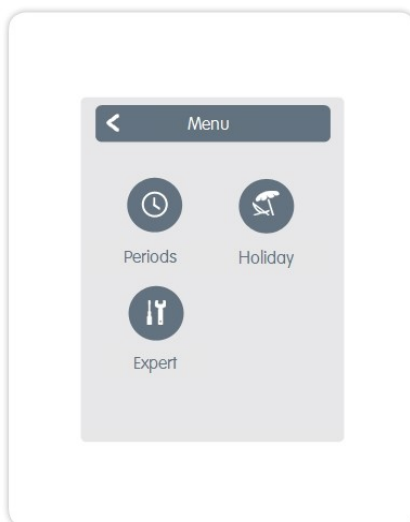

### Holiday

Set time and temperature for the period of absence.



### Expert

Standard settings such as language, time and date, functional options and factory setting.

## Expert Menu

Overview > Operating Mode > Main Menu > Expert

### Language Selection

The configuration of the device language.

### Date & Time

The configuration of the time and date and automatic summer/winter changeover.

### Settings

Settings concerning basic functions such as sensor calibration, location and commissioning.

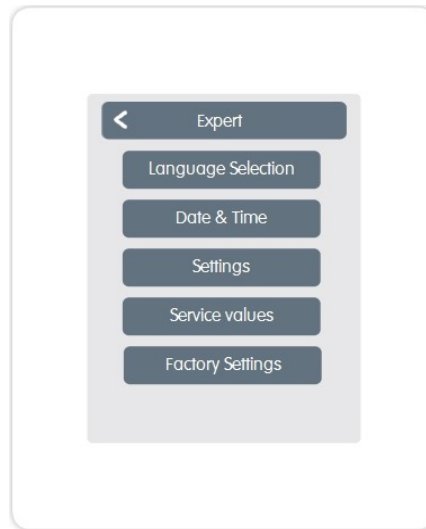

### Service values

Information about the device version and messages such as restarts.

### Factory Settings

The factory settings are restored in the device.

## Expert Menu Settings

Overview > Operating Mode > Main Menu > Expert > Settings

### Functions

Management of local control functions - Thermostat and dehumidifier.

### Location

Set where the device is installed (selection of the room icon).

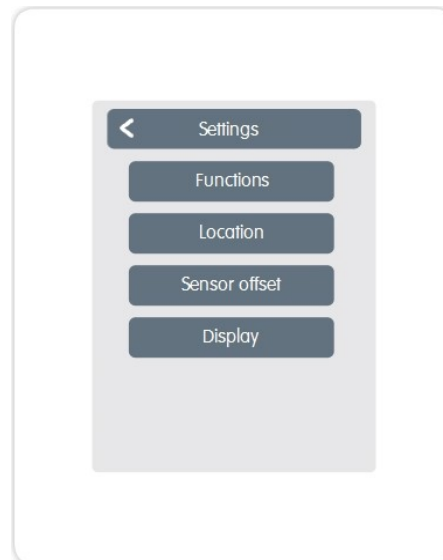

### Sensor calibration

Used to adapt the temperature and humidity of the said local sensor for the selected area.

### Display

Adjustment of display brightness.



### Thermostat

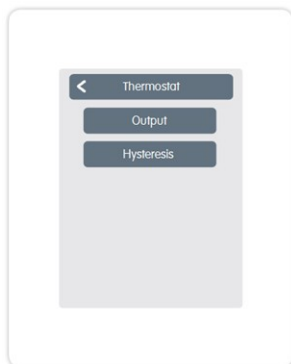

**Output:** Switching output of the function.

**Hysteresis:** Heating hysteresis of the thermostat function in relation to the actual set room temperature.

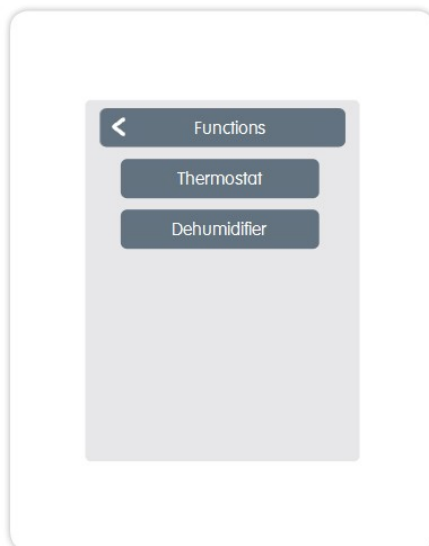

### Dehumidifier

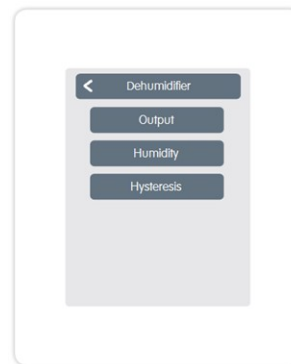

**Output:** Switching output of the function.

**Humidity:** Setpoint of humidity.

**Hysteresis:** Hysteresis of the dehumidifier function with reference to the target value set under humidity.

# Set Operation Hours

Adjustment of individual heating times by a simple copy function for every day.



**Previous/Next week**  
Selects the set day.



**Operating modes**  
Selects the operating mode to individual heating sections.

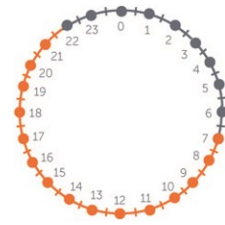
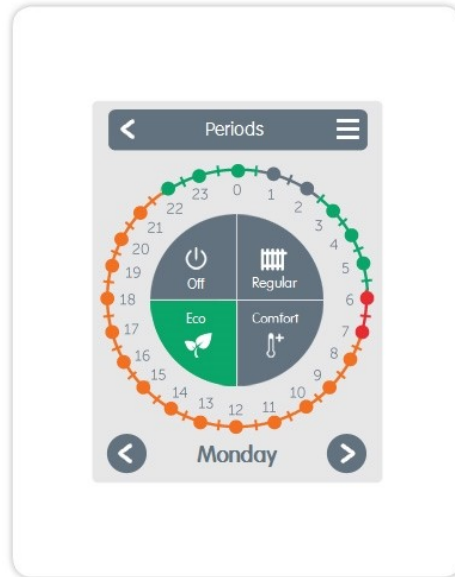

**Clock**  
Time table of the selection in periods of 30 minutes increments.



**Menu**  
Opens the copy function. This function allows you to copy the heating times for the next day, on Monday-Friday or Monday-Sunday.

## Set Operation Hours

### Step 1

Use the arrow keys to select the desired day.

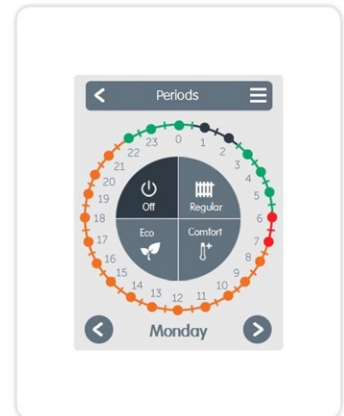
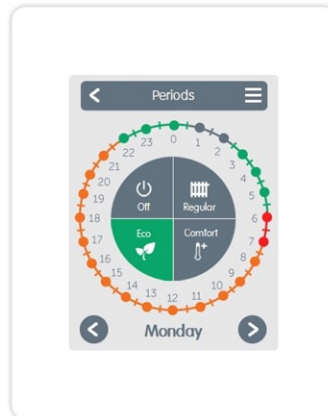
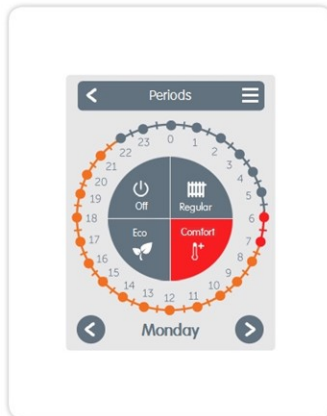

### Step 2

Select the first heating mode (Normal) - with the index finger select the desired length of time. The selected period is colored by selecting the color of the operating mode (normal = orange).

### Step 3

Continue to the next mode (Turbo) and proceed as described above, select the time period for the Turbo Mode.

### Step 4

Continue to the next mode (Eco) and proceed as described above, select the time period for the Eco Mode.

### Step 5

Continue to the next mode (Off) and proceed as described above, select the time period for the Off Mode.

### Step 6

After the completion of the setting of the individual heating times, you have the option of selecting times using the main menu for the next day, or to copy Monday-Friday or Monday-Sunday.

## **Final declaration**

Although these instructions have been created with the greatest possible care, the possibility of incorrect or incomplete information cannot be excluded. Subject as a basic principle to errors and technical changes.

**Date and time of installation:**

**Name of installation company:**

**Space for notes:**

Your specialist dealer:

Manufacturer:

SOREL GmbH Mikroelektronik  
Reme-Str. 12  
D - 58300 Wetter (Ruhr)

+49 (0)2335 682 77 0  
+49 (0)2335 682 77 10

info@sorel.de  
www.sorel.de

Version: 03.07.2018