

°caleon clima

Installation and operating instruction

°CALEON Clima Z Smart Thermostat



Read carefully before installation, commissioning and operation

Content

Safety Instructions	3
EG-Conformity	3
General instructions	3
Changes to the Unit	3
Warranty and Liability	3
Disposal and Pollutants	3
Description °CALEON Clima Z Smart Thermostat	4
Specifications	4
Scope of supply	4
Installation	5
°CALEON Clima Installation	5
Sample wiring	6
Setup	6
Setup procedure	6
Operation	7
Overview of temperatures & humidity	7
Select Operating Mode	7
Main Menu	7
Expert Menu	8
Expert Menu Settings	8
Settings Devices	9
Settings Rooms	10
Settings Functions	11
Wifi Settings	11
CALEON App	11
Set Operation Hours	12
Set Operation Hours	12
Supported Devices and Command Classes	13

SAFETY INSTRUCTIONS

EG-Conformity

By affixing the CE mark to the unit the manufacturer declares that °CALEON Clima Z Smart Thermostat conforms to the following relevant safety regulations:

- EU low voltage directive 2014/35/EU
- EU electromagnetic compatibility directive 2014/30/EU

conforms. Conformity has been verified and the corresponding documentation and the EU declaration of conformity are kept on file by the manufacturer.

General instructions

Please read carefully!

These installation and operating instructions contain basic instructions and important information regarding safety, installation, commissioning, maintenance and the optimal use of the unit. Therefore these instructions must be read and understood completely by the installation technician/specialist and by the system user before installation, commissioning and operation of the unit.

This unit is an automatic, electrical °CALEON Roomthermostat. Install the device only in dry rooms and under environmental conditions as described under "Technical Data".

In addition, observe the applicable accident prevention regulations, the regulations of the Association of Electrical Engineering, the local power supply utility, the applicable DIN-EN standards and the installation and operating instructions for the additional system components. Installation, electrical connection, commissioning and maintenance of the unit may only be carried out by specialists who possess the appropriate training.

Users: Make sure that the specialist gives you detailed information on the function and operation of the unit. Always keep these instructions in the vicinity of the unit.

The manufacturer does not take over any liability for damage caused through improper usage or non-compliance of this manual!

Changes to the Unit

- Changes, additions to or conversion of the unit are not permitted without written permission from the manufacturer.
- It is likewise forbidden to install additional components that have not been tested together with the unit.
- If it becomes clear that safe operation of the unit is no longer possible, for example because of damage to the housing, turn the Unit off immediately.
- Any parts of the unit or accessories that are not in perfect condition must be exchanged immediately.
- Use only original spare parts and accessories from the manufacturer.
- Markings made on the unit at the factory must not be altered, removed or made illegible.
- Only the settings described in these instructions may be set using the Unit.



Changes to the unit can compromise the safety and function of the unit or the entire system.

Warranty and Liability

The Unit has been manufactured and tested with regard to high quality and safety requirements. The warranty and liability shall not include, however, any injury to persons or material damage that is attributable to one or more of the following causes:

- Failure to observe these installation and operating instructions.
- Improper installation, commissioning, maintenance and operation.
- Improperly executed repairs.
- Unauthorized structural changes to the unit.
- Use of the device for other than its intended purpose.
- Operation above or below the limit values listed in the 'Specifications' section.
- Force majeure.

Disposal and Pollutants

The unit conforms to the European RoHS 2011/65/EU for the restriction of the use of certain hazardous substances in electrical and electronic equipment.







Under no circumstances may the device be disposed of with the normal household waste. Dispose of the unit only at appropriate collection points or ship it back to the seller or manufacturer.

DESCRIPTION °CALEON CLIMA Z SMART THERMOSTAT

The °CALEON Roomthermostat is part of a Z-Wave Plus home automation network.

Specifications



	Housing	2-part, ABS plastic 75 mm x 95 mm x 30 mm Glass front
	Display	Capacitive touch panel Color display with 240x320 dots 2.8 inches (7 cm) diagonal
	Operation	Intuitive user guidance
	Language	Deutsch English Español Italiano Français Português

Electrical specifications:

Power supply	100 - 240 VAC, 50 - 60 Hz
Power consumption	max. 2,5 W
Protection category	IP20
Protection class / overvoltage category	0/III

Max. cable length

0-10V/PWM	<3m, if the cable length is ≥ 3 m it is necessary to use a shielded twisted pair bus cable and connect the shield on one side to the protective conductor.
1-Wire Bus	Optional, without function

Permissible Ambient Conditions

during operation	0 °C - 50 °C, no moisture condensation permitted
for transport/storage	0 °C - 60 °C, no moisture condensation permitted

Measuring range

Outside the measuring ranges there are larger deviations	
Internal temperature sensor	0 °C - 60 °C Accuracy +/- 1 °C Resolution 0,1 °C
Internal sensor for rel. humidity	0 % - 100 % Accuracy +/- 6 °C Resolution 0,1 %
1-Wire temperature sensors	Optional, without function

Other Specifications

Installation methods	Wall installation, with/without wall socket
Real Time Clock	RTC with 24 hour power reserve

Scope of supply

- °CALEON Roomthermostat
- 2 screws 3,5 x 35 mm and 2 plugs 6 mm for wall installation.
- °CALEON Clima Z Smart Thermostat installation guide

INSTALLATION

°CALEON Clima Installation

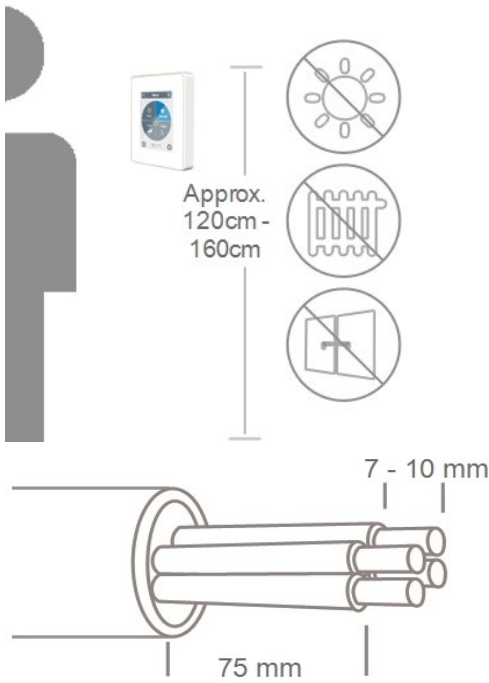

Mount the unit at a suitable location.

 Pay attention to suitable environmental conditions. Direct sunlight, sources of heat and cold, e.g. radiators and windows must be avoided.

Strip cables by 75 mm max. and strip the last 7-10 mm of the wires.

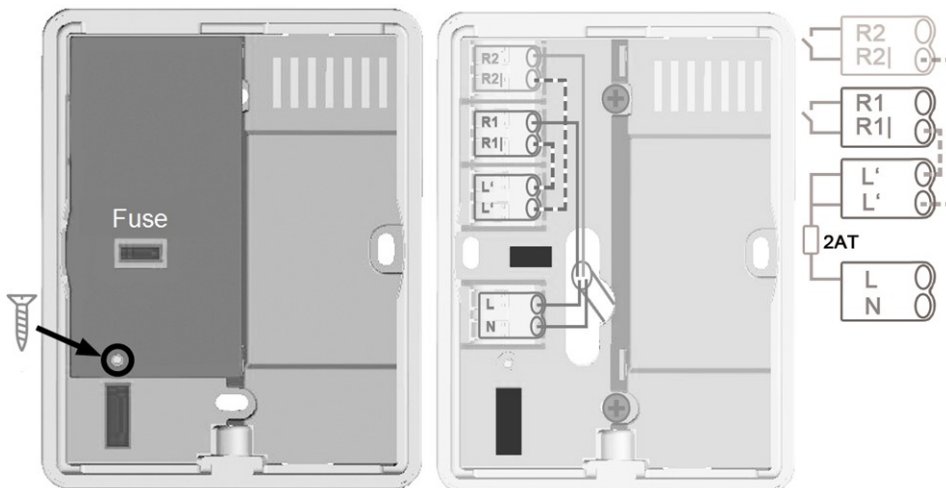

Unscrew the screw, remove the cable cover and connect the electric as described.

 Only mains voltage, no SELV!

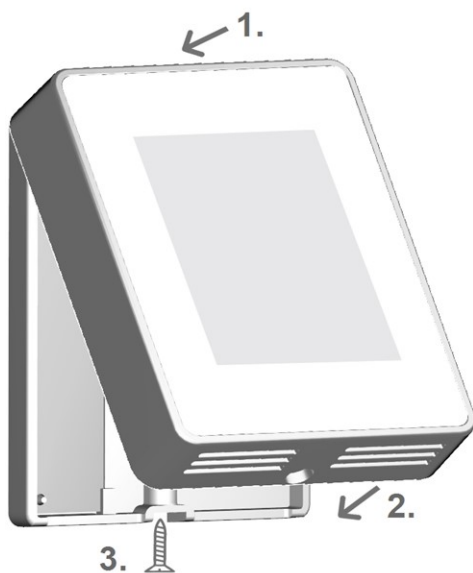

Refit the base and fasten with screw. Switch on mains voltage and place °CALEON in operation.

 The commissioning can be accessed in the °CALEON menu under Expert at any time.

Sample wiring

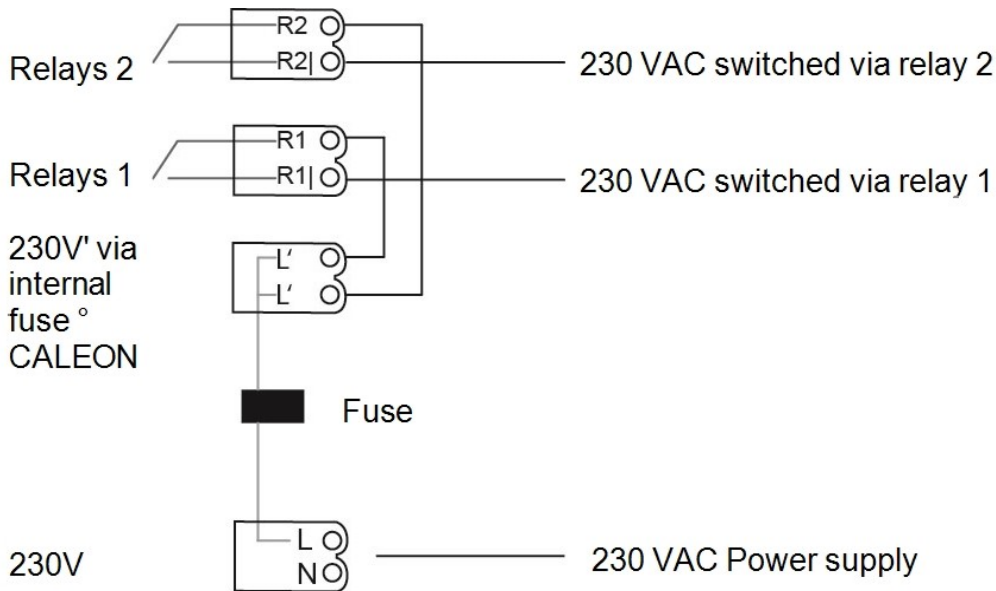

SETUP

Setup procedure

Install device

Install the device as described (see "Sample wiring" on page 6).



Add device

Add Z-Wave devices via the "Expert" menu in the "Settings" menu item under "Devices" (see "Settings Devices" on page 9).



Add Rooms

Use the "Expert" menu in the "Settings" menu item under "Rooms" to add rooms, connect them to the added Z-Wave devices and assign sensors (see "Settings Rooms" on page 10).



Set Functions

Assign a switching output to the respective function via the "Expert" menu in the "Settings" menu item under "Functions" and parameterize it (see "Settings Functions" on page 11).



Install Wifi

Connect the device to the WLAN network via the "Expert" menu in the "Settings" menu item under "Wifi" via the "Select network" menu and add the registered e-mail address in the °CALEON app to the "Access Control" menu.

Overview of temperatures & humidity

It displays room temperature and humidity. If there is no activity for 60 sec., the device is automatically switched to the overview.



Room temperature

Indicates the temperature of the selected Space in 0.1 degree increments.

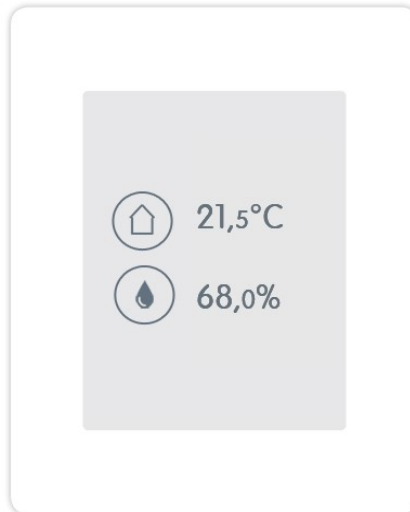

Room humidity

Is the relative humidity of The selected space in 0.1 degree increments.

Select Operating Mode



Back

Navigate back to the overview.



Location/Room

Displays the selected location/room.



Minus/Plus

Change the target temperature +/- 0.5 ° C.

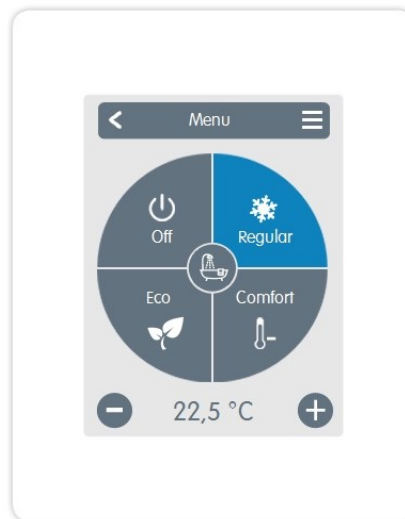

Main menu

Navigate to the main menu



Operating modes

Specifies which operating mode (Normal, Comfort, Eco and Off) is selected. The selected mode is shown in color. By pressing the plus and minus keys it is possible to adjust the setpoint temperature of the modes.

Main Menu

Overview > Operating Mode > Main Menu



Heating/Cooling

Switch between heating and cooling modes.



Periods

Adjustment of individual heating resp. cooling times for each weekday with copy function for subsequent days.

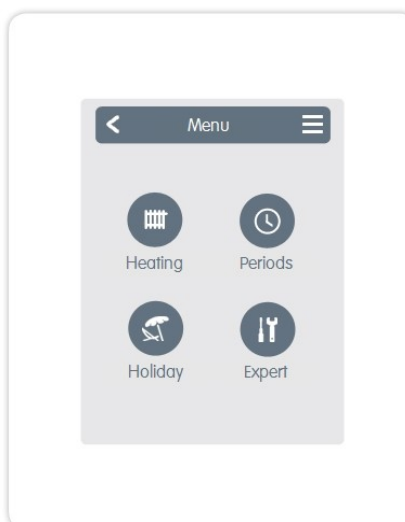

Holiday

Set time and temperature for the period of absence.



Expert

Standard settings such as language, time and date, functional options and factory setting.

Expert Menu

Overview > Operating Mode > Main Menu > Expert

Language Selection

The configuration of the device language.

Date & Time

The configuration of the time and date and automatic summer/winter changeover.

Settings

Settings concerning basic functions such as sensor calibration, functions, Z-Wave devices, location and commissioning.

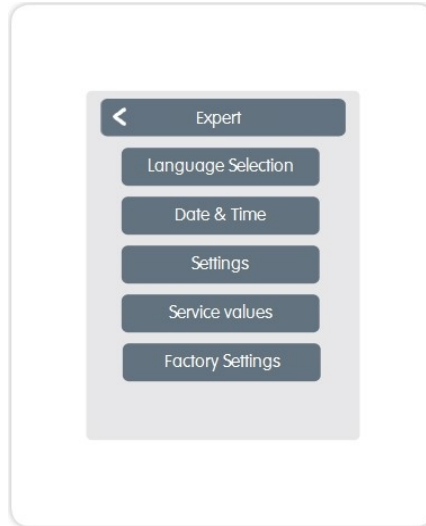

Service values

Information about the device version, messages such as restarts, Wifi and Z-Wave status.

Factory Settings

The factory settings are restored in the device.

Expert Menu Settings

Overview > Operating Mode > Main Menu > Expert > Settings

Devices

Management of all Z-Wave and 1-Wire devices in the network.

Rooms

Management and assignment of rooms and devices.

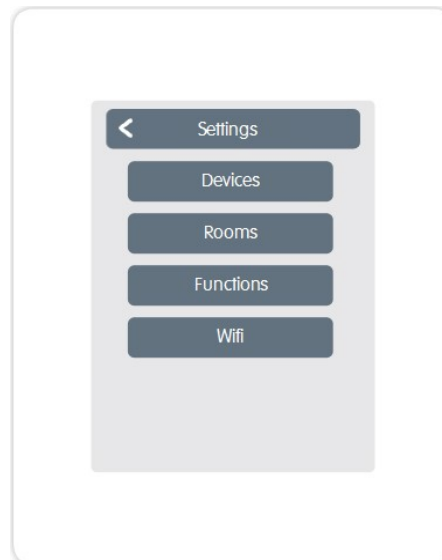

Functions

Management of local control functions - Thermostat and dehumidifier.

Wifi

Settings for: SSID, password, DHCP, access control, Wifi status and network.

Z-Wave Network

This product can be integrated and operated in any Z-Wave network with other Z-Wave certified devices from other manufacturers and/or other applications. All non-battery powered nodes within the network are used as repeaters independent of the Manufacturers act to increase the reliability of the network.

Overview > Operating Mode > Main Menu > Expert > Settings > Devices

The "Devices" menu displays a list of all Z-Wave devices in the network.



Device icon

Shows the type of connected device and its number assigned in °CALEON.

Name

Shows the received name of the device.



Unknown devices

Devices not supported by °CALEON.

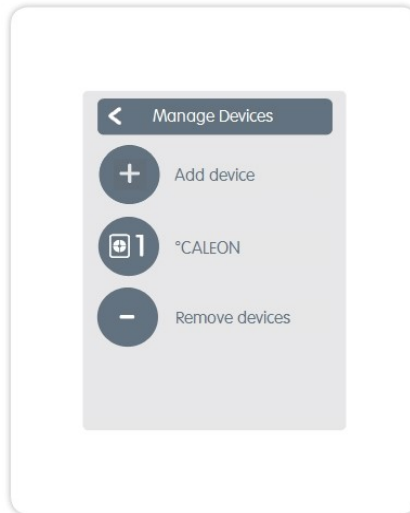

Add device

Starts the search for new available devices in the network.

Z-Wave devices need to be included into the network before they can be used. This process, known as inclusion, it requires to set the controller in inclusion mode, and after that activating the inclusion mode at the end device (refer to the device manual for this).

If °CALEON is your Z-Wave controller activate the inclusion mode via "Add device" in the "Devices" Menu and then putting the end device into its inclusion mode. **Expert -> Settings -> Devices -> Add Device.**

If °CALEON have to be dedicated to existing Z-Wave controller, include it to the controller via "Join Network" in the "°CALEON" menu after activating the inclusion mode in the existing controller. **Expert -> Settings -> Devices -> °CALEON -> Join Network.**

Overview > Operating Mode > Main Menu > Expert > Settings > Devices > °CALEON

Sensor calibration

Used to adapt the temperature and humidity of the said local sensor for the selected area.

Display

Adjustment of display brightness.

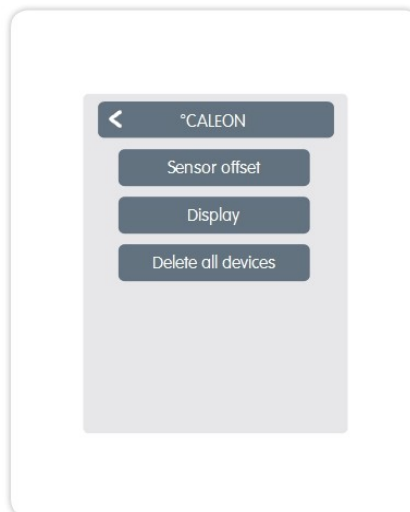

Delete all devices

All devices in the network are deleted and the Z-Wave network settings are reset.

Sensor calibration

For adapting the measured values of the sensor.

Icon

Assigns a icon to the Z-Wave device.

Association

Connects the Z-Wave device directly to other Z-Wave devices.

Disassociation

Deletes the connection to other devices.

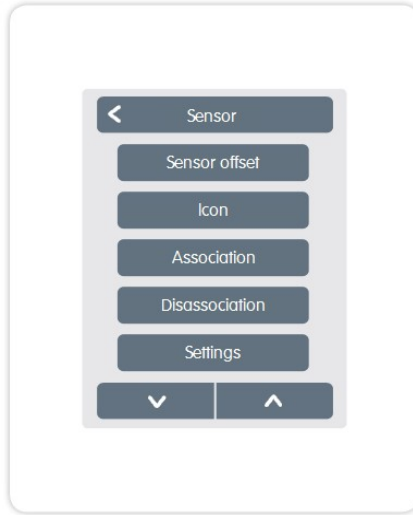

Settings

Device-specific settings. See the manufacturer's manual.

Remove device

Removes the device from the Z-Wave network.

Settings Rooms

The "Rooms" menu displays a list of all assigned rooms.



Room icon

Name

Displays the name of the device.

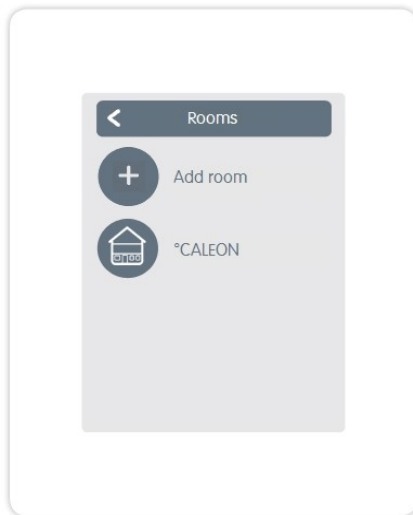

Add room

Starts the search for new available devices in the network.

Location

Displays where the device is installed (selection of the room icon).

Sensor

Displays the type of sensor.

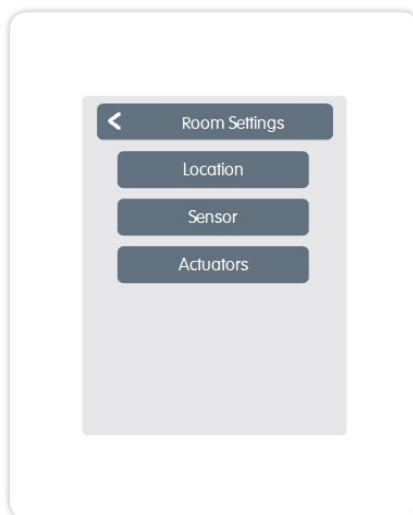

Actuators

Displays the actuators associated with the room and their activity.

Settings Functions

Overview > Operating Mode > Main Menu > Expert > Settings > Functions

Thermostat

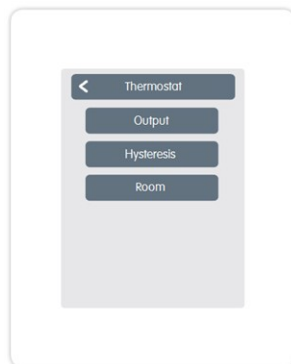

Output: Switching output of the function.

Hysteresis: Heating hysteresis of the thermostat function in relation to the actual set room temperature.

Room: location of the function.

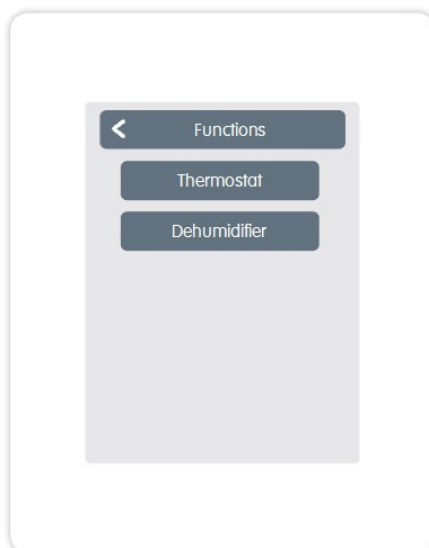

Dehumidifier

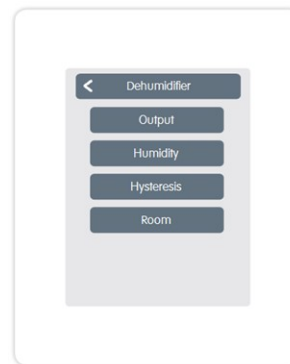

Output: Switching output of the function.

Humidity: Setpoint of humidity.

Hysteresis: Hysteresis of the dehumidifier function with reference to the target value set under humidity.

Room: location of the function.

Wifi Settings

Overview > Operating Mode > Main Menu > Expert > Settings > Wifi

The "Wifi" menu displays....

Activate Wifi

Activate/deactivate WLAN connection.

Wifi-Status

Displays the status of the wireless connection.

Select network

Displays all available wireless connections.

Access Control

Here entered e-mail addresses have access to the device.

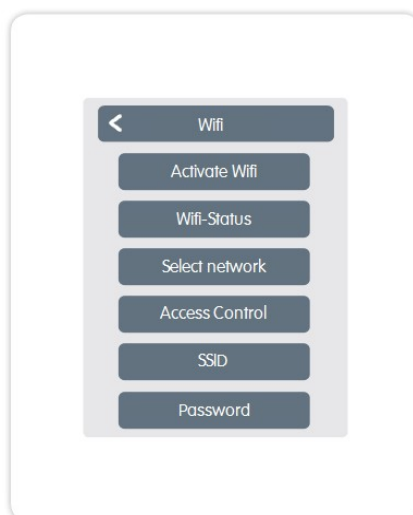

SSID

SSID is the name of the WLAN network. Hidden networks can be found manually. Alternative to "Select network".

Password

WLAN password

Enable DHCP

DHCP determines whether the device gets the network configuration from the server or whether the network is set manually.

CALEON App

°CALEON can be remote controlled from a smartphone or tablet.

1. Download the °CALEON App in the App Store, currently Google Play (Android) and Apple App Store (IOS), on your mobile device.
2. Activate the app and register with your e-mail address.
3. Check the activation email in your email account and click the confirmation link.
4. Unlock the remote control in °CALEON. Enter the e-mail address (with which you have registered in the app) in the "Access Control" menu. **Expert -> Settings -> Wifi -> Access Control**
5. Login to the app with your email address and password.
6. Use your mobile device to control °CALEON.

Set Operation Hours

Overview > Operating Mode > Main Menu > Timer

For the operating modes heating and cooling own mode-related times are set. To do this, first switch to the heating mode and define the corresponding times for this operating mode under Main menu > Times. Then change to the cooling mode and define the corresponding times for this operating mode under Main menu > Timer.

Adjustment of individual heating resp. cooling times by a simple copy function for every day.



Previous/Next week
Selects the set day.



Operating modes
Selects the operating mode to individual heating resp. cooling sections.

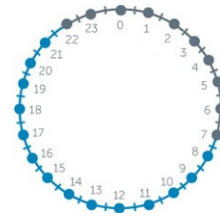
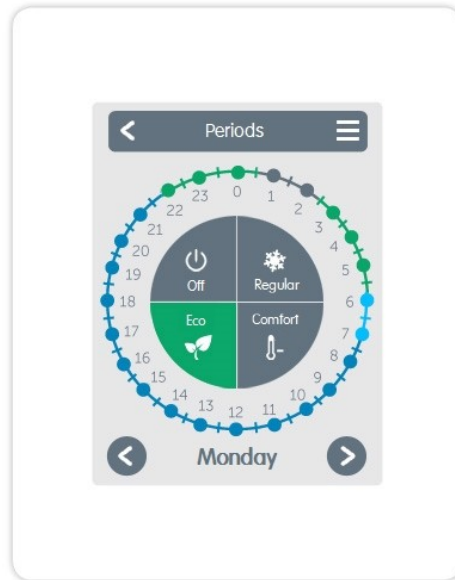

Clock
Time table of the selection in periods of 30 minutes increments.



Menu
Opens the copy function. This function allows you to copy the heating resp. cooling times for the next day, on Monday-Friday or Monday-Sunday.

Set Operation Hours

Step 1

Use the arrow keys to select the desired day.

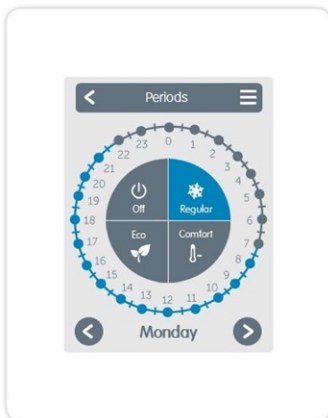

Step 2

Select the first heating mode (Normal) - with the index finger select the desired length of time. The selected period is colored by selecting the color of the operating mode (normal = blue).

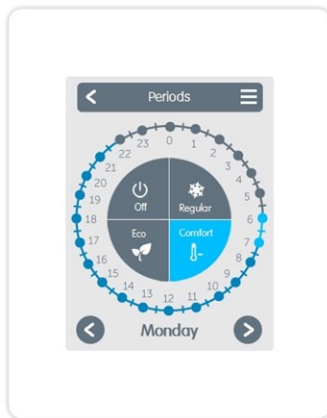

Step 3

Continue to the next mode (Turbo) and proceed as described above, select the time period for the Turbo Mode.

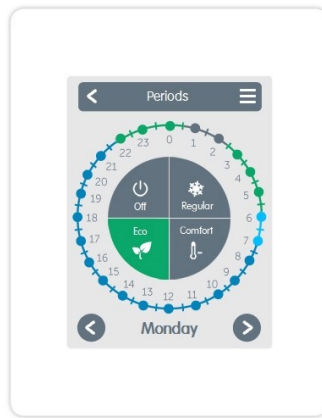

Step 4

Continue to the next mode (Eco) and proceed as described above, select the time period for the Eco Mode.

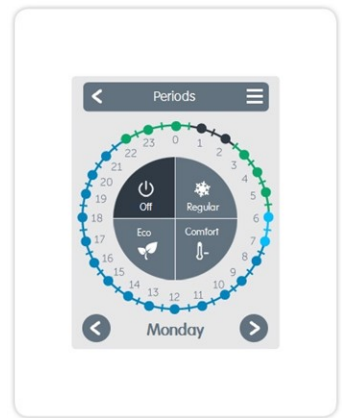

Step 5

Continue to the next mode (Off) and proceed as described above, select the time period for the Off Mode.

Step 6

After the completion of the setting of the individual heating resp. cooling times, you have the option of selecting times using the main menu for the next day, or to copy Monday-Friday or Monday-Sunday.

Final declaration

Although these have been created with the greatest possible care, the possibility of incorrect or incomplete information cannot be excluded. Subject as a basic principle to errors and technical changes.

Date and time of installation:

Name of installation company:

Space for notes:

Your specialist dealer:

Manufacturer:

SOREL GmbH Mikroelektronik
Reme-Str. 12
D - 58300 Wetter (Ruhr)

+49 (0)2335 682 77 0
+49 (0)2335 682 77 10

info@sorel.de
www.sorel.de

Version: 03.07.2018