

Storage Loading Controller SLC Plus

Installation and operating instructions



Read carefully before installation, commissioning and operation

CONTENT

Safety Instructions	3	Circulations periods	16
EU-Conformity	3	AL-heating	16
General Instructions	3	Error Messages	17
Explanation of Symbols	3	Error message	17
Changes to the Unit	4	Primary pump	17
Warranty and Liability	4	Sludge purge	17
Disposal and Pollutants	4	Interval	17
Description SLC Plus	5	Weekday	17
Technical Data	5	Time	17
About the Controller	6	Contin. Operation	17
Scope of Supply	6	Primary Mixer	17
Hydraulic Variants	6	Direction open=left	17
Installation	7	Turn Time	17
Electrical Terminals	7	Pause Factor	17
Wall Installation	8	burner	17
Electrical Connection	8	Delay	18
Installing the Temperature Sensors	9	Relay mode	18
Temperature Resistance Table for Pt1000 Sensors	9	Burner offset	18
Operation	9	Parallel operation V1/V2	18
Display and Input	9	Parallel operation	18
Commissioning help	10	Delay	18
1. Measurement values	11	Follow-up time	18
2. Statistics	11	Always on	18
Operating hours	11	Signal V1/V2	18
Heat quantity	11	Pressure Monitoring	18
Graphic overview	11	Pressure Monitoring	18
Message Log	11	Pmin	18
Reset / Clear	11	Pmax	19
3. Operating Mode	12	Sensor Calibration	19
Auto	12	Commissioning	19
Manual	12	Factory settings	19
Aus	12	Time & Date	19
4. Settings	13	Daylight saving time	19
Tmax	13	Eco Display Mode	19
Storage target temperature	13	Temperature unit	19
Switch Off hysteresis	13	Network	19
Complete loading	13	Access Control	19
Heating times	13	Ethernet	20
Circulation	13	CAN bus ID	20
Sludge purge	13	Sensor send interval	20
Primary Mixer	13	7. Menu Lock	21
Direction open=left	13	8. Service Values	21
Turn Time	13	9. Language	21
Pause Factor	13	Malfunctions/Maintenance	22
burner	14	Tips	22
5. Protective Functions	14		
Anti-Legionella	14		
Seizing Protection	14		
6. Special Functions	15		
Program selection	15		
Pump settings / Signal V1	15		
Type of pump/ Type of signal	15		
Pump/ Profile	15		
Output Signal	15		
PWM / 0-10V off	15		
PWM / 0-10V on	15		
PWM / 0-10V max.	15		
Show signal	15		
Speed control	15		
Max. Speed	15		
Min. Speed	16		
Relay functions	16		
Circulation	16		
Circulation	16		
Tmin	16		
Hysteresis	16		

EU-Conformity

By affixing the CE mark to the unit the manufacturer declares that the SLC Plus conforms to the following relevant safety regulations:

- EU low voltage directive 2014/35/EU
- EU electromagnetic compatibility directive 2014/30/EU

conforms. Conformity has been verified and the corresponding documentation and the EU declaration of conformity are kept on file by the manufacturer.

General Instructions

Please read carefully!

These installation and operating instructions contain basic instructions and important information regarding safety, installation, commissioning, maintenance and the optimal use of the unit. Therefore these instructions must be read and understood completely by the installation technician/specialist and by the system user before installation, commissioning and operation of the unit.

This unit is an automatic, electrical Storage loading controller. Install the unit only in dry areas and under the ambient conditions described in "Specifications".

The valid accident prevention regulations, VDE regulations, the regulations of the local power utility, the applicable DIN-EN standards and the installation and operating instruction of the additional system components must also be observed.

Under no circumstances does the unit replace any safety devices to be provided by the customer!

Installation, electrical connection, commissioning and maintenance of the device may only be carried out by an appropriately trained specialist. Users: Make sure that the specialist gives you detailed information on the function and operation of the unit. Always keep these instructions in the vicinity of the unit.

The manufacturer does not take over any liability for damage caused through improper usage or non-compliance of this manual!

Explanation of Symbols



Danger

Failure to observe these instructions can result in electrocution.



Danger

Failure to observe these instructions can result in serious damage to health such as scalding or life-threatening injuries.



Caution

Failure to observe these instructions can result in destruction of the unit or the system, or environmental damage.



Caution

Information which is especially important for the function and optimal use of the unit and the system.

Changes to the Unit

- Changes, additions to or conversion of the unit are not permitted without written permission from the manufacturer.
- It is likewise forbidden to install additional components that have not been tested together with the unit.
- If it becomes clear that safe operation of the unit is no longer possible, for example because of damage to the housing, turn the Unit off immediately.
- Any parts of the unit or accessories that are not in perfect condition must be exchanged immediately.
- Use only original spare parts and accessories from the manufacturer.
- Markings made on the unit at the factory must not be altered, removed or made illegible.
- Only the settings described in these instructions may be set using the Unit.



Changes to the unit can compromise the safety and function of the unit or the entire system.

Warranty and Liability

The Unit has been manufactured and tested with regard to high quality and safety requirements. The warranty and liability shall not include, however, any injury to persons or material damage that is attributable to one or more of the following causes:

- Failure to observe these installation and operating instructions.
- Improper installation, commissioning, maintenance and operation.
- Improperly executed repairs.
- Unauthorised structural changes to the unit.
- Use of the device for other than its intended purpose.
- Operation above or below the limit values listed in the 'Specifications' section.
- Force majeure.

Disposal and Pollutants

The unit conforms to the European RoHS 2011/65/EU for the restriction of the use of certain hazardous substances in electrical and electronic equipment.



Under no circumstances may the device be disposed of with the normal household waste. Dispose of the unit only at appropriate collection points or ship it back to the seller or manufacturer.

Technical Data

Electrical specifications:

Power Supply		100 - 240VAC, 50 - 60 Hz
Power consumption / standby		0,5W - 2,5W/ 0,5W
Internal fuse	1	2A slow blow 250V
Protection Class		IP40
Protection Class		II
Overvoltage category		II
Degree of pollution category		II

Inputs/Outputs

Sensor inputs	6	PT1000 temperature sensors	-40 °C ... 300 °C
Sensor inputs VFS	2	Grundfos Direct Sensor	
Outputs mechanical relay	4	4	
mechanical relay	R1 - R4	460VA for AC1 / 460VA for AC3	
0-10V/PWM output	V1 - V2	for 10 k Ω working resistance 1 kHz, level 10 V	

Max. Cable Length

Flow sensors	< 3 m
CAN	< 3 m; at \geq 3 m, a shielded twisted pair cable must be used. Isolate shielding and connect it to the protective conductor of only one of the devices. Max. cable length of the complete system 200 m.
0-10V/PWM	< 3 m

Permissible Ambient Conditions

for controller operation	0 °C - 40 °C, max. 85 % rel. humidity at 25 °C
for transport/storage	0 °C - 60 °C, no moisture condensation permitted

Other Specifications and Dimensions

Housing Design	2-part, ABS plastic
Installation Methods	Wall installation, optionally panel installation
Overall dimensions	163 mm x 110 mm x 52 mm
Aperture installation dimensions	157mm x 106mm x 31mm
Display	Fully graphical display, 128 x 64 pixel
Real Time Clock	RTC with 24 hour power reserve
Operation	4 entry keys

About the Controller

The Storage loading controller SLC Plus facilitates efficient use and function control of your solar or heating system possible while its handling is intuitive. After every input step the suitable functions are matched to the keys and explained in a text above. In the menu 'measurement values and settings' are help text and graphics in addition to key words.

The SLC Plus can be used for the various system variants.

Important characteristics of the SLC Plus are:

- Depiction of graphics and texts using a lit display.
- Simple viewing of the current measurement values.
- Statistics and system monitoring by means of statistical graphics
- Extensive setting menus with explanations.
- Menu block can be activated to prevent unintentional setting changes.
- Resetting to previously selected values or factory settings.

Scope of Supply

- Storage Loading Controller
- SLC Plus installation and operating instructions

Optionally contained depending on design/order:

- Pt1000 temperature sensor and submersing cases
- External switching relay for V1/V2: Art. No. 10322

Hydraulic Variants



The following illustrations should be regarded only as schematic representations of the respective hydraulic systems and do not claim to be complete. Under no circumstances should the controller replace any safety devices. Depending on the specific application, additional system and safety components such as check valves, non-return valves, safety temperature limiters, scalding protectors, etc., may be required.

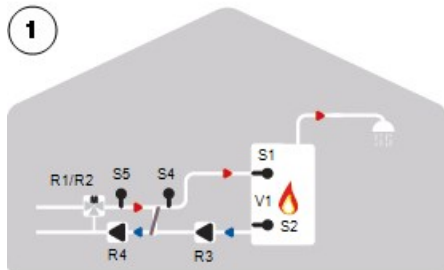

Mixing valve control

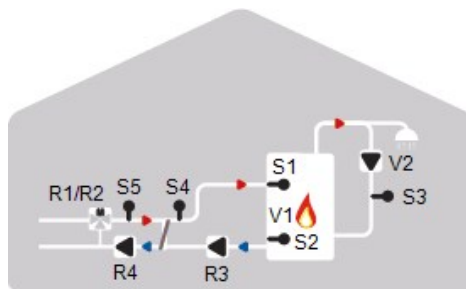

Mixing valve control with circulation

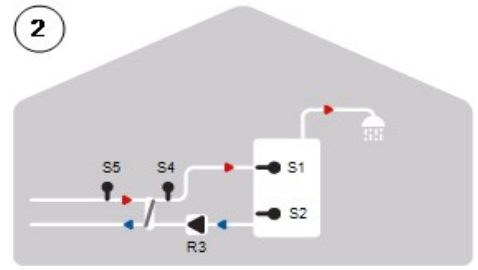

Storage loading without VFS

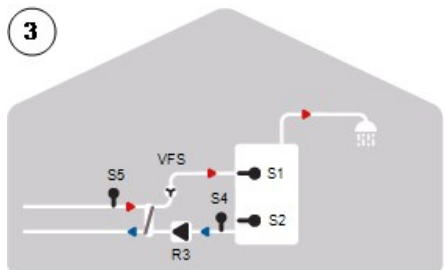

Storage loading with VFS



In addition to the program variants available in the controller, additional functions on free relays/signal outputs can be flexibly configured. The variants shown here are examples of possible functional combinations.

Electrical Terminals



Low voltages
max. 24 VAC / DC



Mains voltages
100 - 240 VAC, 50 - 60 Hz

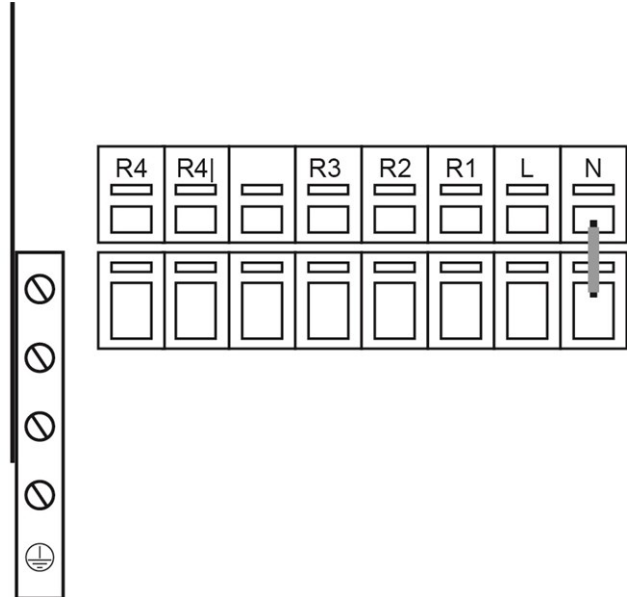
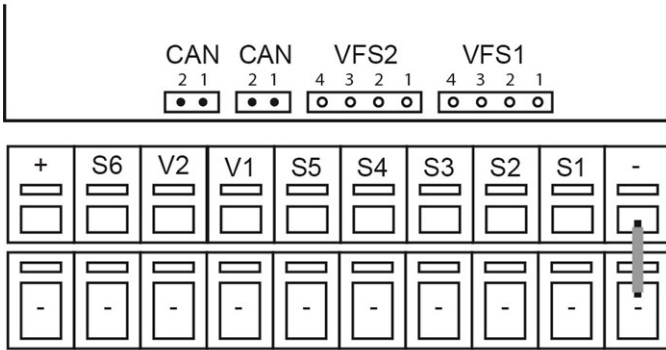

Terminal: Connection for:

S1	Storage top temperature / secondary pump activation
S2	Storage bottom temperature / secondary pump deactivation
S3	Circulation temp. (opt.)
S4	Primary Flow temp.
S5	Charge temperature
V1	0-10V signal output for burner request (factory setting) or error messages. The signal output can be used to control higher voltages via a potential-free relay (optional accessory).
V2	0-10V signal output for additional functions circulation or error messages. The signal output can be used to control higher voltages via a potential-free relay (optional accessory).
S6	Primary return flow temperature (optional)
+	24V Power supply

The connection of the ground wire is made at the lower gray terminal block.

CAN To connect several controllers with each other using a CAN cable. Terminate the CAN Bus on both ends using resistors, with the assignment of the CAN bus connectors being arbitrary!

For circulation pumps that are not speed-controlled (standard/high-efficiency pumps), the power supply can be provided via the external relay (optional accessory).

Terminal: Connection for:

N	Network neutral conductor N
L	Network outer conductor L
R1	Primary Mixer "open"
R2	Primary Mixer "close"
R3	Power supply (L') primary pump
R4	Power supply (L') primary pump
R4	Power supply (L') (230V permanent voltage via internal fuse)

The neutral conductor N must be connected to the N terminal block.

The PE protective conductor must be connected to the PE metal terminal block!

Wall Installation

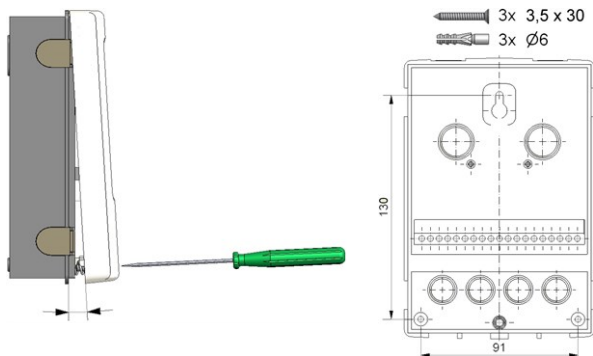

1. Unscrew cover screw completely.
2. Carefully pull upper part of housing from lower part. During the removal, the brackets are released as well.
3. Set upper part of housing aside. Do not touch the electronics.
4. Hold the lower part of the housing in the selected position and mark the 3 mounting holes. Make sure that the wall surface is as even as possible so that the housing does not become distorted when it is screwed on.
5. Using a drill and size 6 bit, drill three holes at the points marked on the wall and push in the plugs.
6. Insert the upper screw and screw it in lightly.
7. Fit the upper part of the housing and insert the other two screws.
8. Align the housing and tighten the three screws.

If problems occur with the operation of the terminals, our video on our YouTube page can help you:

YouTube





<http://www.sorel.de/youtube>

Electrical Connection

 Before working on the unit, switch off the power supply and secure it against being switched on again! Check that there is no power flowing! Electrical connections may only be made by a specialist and in compliance with the applicable regulations. The unit may not be put into operation if there is visible damage to the housing, e.g. cracks.

 The unit may not be accessible from behind.

 Low-voltage cables such as temperature sensor cables must be routed separately from mains voltage cables. Feed temperature sensor cables only into the left-hand side of the unit, and mains voltage cables only into the right-hand side.

 The customer must provide an all-pole disconnecting device, e.g. an emergency heating switch.

 The cables being connected to the unit must not be stripped by more than 55 mm, and the cable jacket must reach into the housing just to the other side of the strain relief.

Installing the Temperature Sensors

The controller operates with Pt1000 temperature sensors which are accurate to 1 °C, ensuring optimal control of system functions.

! If desired, the sensor cables can be extended to a maximum of 30 m using a cable with a cross-section of at least 0.75 mm². Ensure there is no contact resistance! Position the sensor precisely in the area to be measured! Only use immersion, pipe-mounted or flat-mounted sensors suitable for the specific area of application with the appropriate permissible temperature range.

! Low-voltage cables such as temperature sensor cables must be routed separately from mains voltage cables. Feed temperature sensor cables only into the left-hand side of the unit, and mains voltage cables only into the right-hand side.

Temperature Resistance Table for Pt1000 Sensors

°C	-20	-10	0	10	20	30	40	50	60	70	80	90	100
Ω	922	961	1000	1039	1077	1116	1155	1194	1232	1270	1308	1347	1385

Operation

Display and Input

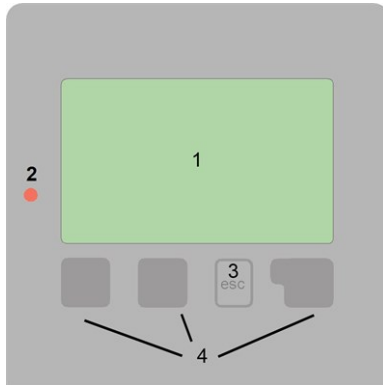

The display's (1), extensive text and graphical mode, enables simple, almost self-explanatory, operation of the controller.







The function of the other 3 keys (4) is shown in the display right above the keys. The right-hand key generally has a confirmation and selection function.



The graphics mode appears if not key is pressed for 2 minutes or after exiting the main menu with 'esc'.



Hitting the "esc" key in the graphics mode takes you directly to the main menu.

-  Pump (rotates when active)
-  Mixer (black when active)
-  Storage / buffer
-  Hot water storage tank
-  Temperature Sensors
-  heat exchanger

Further symbols can be found in the special functions

Examples for key settings:

- +/- Increase / decrease values
- ▼/▲ Scroll menu down / up
- Yes/No agree / reject
- About further information
- Back to the previous display
- Ok Confirm selection
- Confirm Confirm setting

Commissioning help

Setup wizard

Would you like to start the setup wizard?

no **yes**

1. Set language and time
2. Commissioning help / setup wizard
 - a) select or
 - b) skip.

The setup wizard guides through the necessary basic settings in the correct order. Every parameter is explained on the display of the controller. Pressing the "esc" key takes you back to the previous setting.

b) With free commissioning the settings should be made in the following order:

- Menu 9. Language
- menu 3. Time, Date and Operating Times.
- Menu 4. Settings, all values
- Menu 5. Protection Functions (if any adjustments necessary).
- menu 6. Special Functions (if any adjustments necessary).

3. In menu operating mode "3.2. Manual", test the witch outputs with the consumers connected and check the sensor values for plausibility. Then set to automatic mode. See "Manual" on page 12



The setup wizard can be accessed in menu 6.14. at any time.



Consider the explanations for the individual parameters on the following pages and check if further settings are necessary for your application.

1. Measurement values

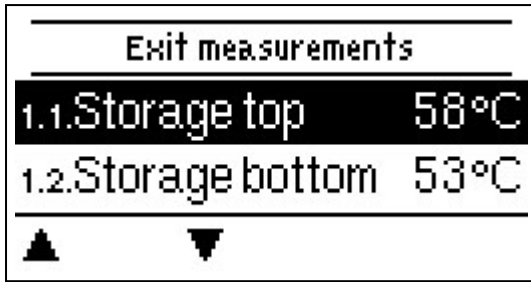

Serve to display the current measured temperatures.



If ,error' appears on the display instead of the measurement value, there may be a defective or incorrect temperature sensor.



If the cables are too long or the sensors are not well-placed, small deviations in the measurement values may occur. In this case, the display values can be compensated by adjustments in the controller See "Sensor Calibration" on page 19. The selected program, connected sensors and the specific model design determine which measurement values are displayed.

2. Statistics



Serve for function control and long-term monitoring of the system.



For time-dependent functions such as circulation and anti-legionella and the evaluation of system data, it is essential that the time is accurately set on the controller. Please note that the clock continues to run for about 24 hours if the mains voltage is interrupted, and afterward must be reset. Improper operation or an incorrect time may result in data being cleared, recorded incorrectly or overwritten. The manufacturer accepts no liability for the recorded data!

Operating hours

Here the operating hours of the heating circuit and other switch or signal outputs are displayed. This is the entire time the heating circuit pump and other switch or signal outputs were active. The displayed date in this menu is the date of the last deletion. From this date on the current count is added.

Heat quantity

Display of the consumed heat quantity form the system in kWh.



This is an indicative value.

Graphic overview

This results in a clear illustration of the data as a bar graph. Different time ranges are available for comparison. You can page through with the two left keys.

Message Log

Display of the last 20 errors in the system with indication of date and time.

Reset / Clear

Resetting and clearing the selected statistics. Selecting ,all statistics' clears everything except the messages.

3. Operating Mode

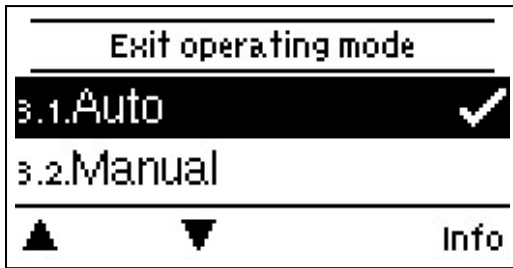

Auto

The automatic mode is the normal mode of the controller. A correct controller function under consideration of the current temperatures and the set parameters is only present in automatic mode! After an interruption of the mains voltage, the controller automatically returns to the last operating mode selected.

Manual

The individual relay outputs, v outputs and the connected consumers can be checked for proper functioning and correct assignment.

 The operating mode 'Manual' may only be used by specialists for brief function tests, e.g. during commissioning! Function in manual mode: The relays and thus the connected consumers are switched on and off by pressing a key, with no regard to the current temperatures and set parameters. At the same time, the current measurement values of temperature sensors are also shown in the display for the purposes of function control.

Aus

 If the operating mode "off" is enabled, all control functions are turned off. The measured temperatures are displayed for the overview.

4. Settings

Exit settings	
+1.Tmax	70°C
+3.Tset storage	59°C
▲	▼
	Info



By no means does the controller replace the safety appliances on site!

Tmax

Maximum charging temperature measured at S4. If it is exceeded, the primary pump is switched off. If the temperature falls below the set temperature, the pump is released again.

Storage target temperature

Storage target temperature

If this value falls below this value at the associated storage sensor during the enabling times for heating, the heating is started. The storage target temperature is composed of the set value + the switch-off hysteresis.

Switch Off hysteresis

Switch-off hysteresis for storage heating

The storage target temperature is calculated from Tmin or Tset storage at the given operating time plus the hysteresis set here. If the target temperature at the corresponding storage sensor is reached, storage heating is switched off.

Complete loading

With the complete loading function, the storage is heated up to the lower storage sensor (S2). If complete loading is deactivated, heating switches off when the target storage temperature at the upper storage sensor (S1) is reached. The storage heating is always switched on via the storage sensor S1.

Heating times

Enable period for storage heating.

In this menu, the operating times for storage heating are selected, whereby 3 periods can be defined for each day of the week and copied to the following days.

Circulation

If circulation has been selected and activated in the menu item Special functions/ Relay 1, the following settings can be made: Siehe "Zirkulation" auf Seite 1

Sludge purge

If the sludge purge has been selected and activated in the menu special functions, the following settings can be made: See "Sludge purge" on page 17

Primary Mixer

When this function is activated, water is mixed in the primary circuit by a mixer via the primary return. As a result, less energy is drawn from the storage tank at high storage tank temperatures, depending on the flow rate, since energy is mixed from the return flow.

Direction open=left

Direction of the mixing valve can be set here.

Turn Time

Length of turn time.

Pause Factor

Adjustment of mixer pause time.

burner

If the burner has been selected and activated in the menu Special functions/Signal V2, the following settings can be made: See "burner" on page 17

5. Protective Functions



The 'Protective functions' can be used by specialists to activate and set various protective functions.





By no means does the controller replace the safety appliances on site!

Anti-Legionella

 The anti-legionella function is an additional function for certain relay functions such as: electric heating rod, burner, circulation, compressor.

With the help of the anti legionella function (hereinafter referred to as: AL), the system can be heated up at selected times in order to free it of legionella.

 In the delivery state, the anti legionella function is switched off.

 As soon as it has heated up with "AL" turned on, information with the date will be shown in the display.

 This anti legionella function does not offer any secure protection against legionella, because the controller requires an adequate added amount of energy and the temperatures cannot be monitored in the entire storage area and the connected pipe system. For secure protection against legionella, a heating up to the required temperature as well as a simultaneous circulation of water in the storage and pipe system must be guaranteed through energy sources and external control devices.

 During the operation of the anti legionella function, if applicable, the storage is heated above the set value "Tmax", which may lead to scalding and system damage.

AL Tset

For a successful heating, this temperature has to be reached at the AL sensor(s) for the exposure time period.

AL residence time

For this period of time the AL Tset temperatures at the activated AL-sensors have to be reached for a successful heating.

Last AL heat

This displays when the last successful heating has occurred.

AL-times

During this periods the AL heat up is attempted. If within the defined period, the AL-condition is met (Tset at the defined sensors for the exposure time period), the heating is completed and logged as "Last AL heating".

Start manually

The anti-Legionella heating can be started manually at any time.

Seizing Protection

If the anti-seizing protection is activated (daily, weekly, off), the controller switches the outputs on/off at 12:00 noon for 5 seconds to prevent seizing of the pump/valve after long periods of inactivity.

6. Special Functions



Used to set basic items and expanded functions.



The settings in this menu should only be changed by a specialist.

Program selection

Here the hydraulic variation fitting to the respective use case is selected and set.



The program selection normally occurs only once during the first entry into service by a specialist. An incorrect program selection may lead to unpredictable errors.

Pump settings / Signal V1

In this menu, the settings for the speed controlled output V1 are executed.

Type of pump/ Type of signal

The type of speed controlled pump used can be set here.

0-10V: Control of special pumps (e.g. high efficiency pumps) through a 0-10V signal.

PWM: Control of special pumps (e.g. high efficiency pumps) through a PWM signal.

Pump/ Profile

In this menu, the preset profiles for the pump can be selected or under "manual" all settings can be done personally. The settings can still be changed after a profile has been selected.

Output Signal

In this menu the type of actors are set: heating pumps have the greatest output with a small input signal, solar pumps in contrast have very little output with a small input signal. Solar = normal, heating = inverted.

PWM / 0-10V off

This signal / this voltage is emitted if the actor is turned off (actor with cable break detection require a minimum voltage / a minimum signal).

PWM / 0-10V on

This voltage / this signal requires the pump in order to turn on and to run at a minimum speed.

PWM / 0-10V max.

With this value, the maximum signal / maximum voltage level can be specified for the highest speed of the energy saving valve, which is used, for example, during the purging or manual operation.

Show signal

Represents the set signal in a graphic and text overview.

Speed control

If the speed control is activated, it SLC Plus offers the possibility through a special internal electronic system to change the speed of pumps depending on the process. The PWM and 0-10V outputs can work speed-controlled.



This function should only be activated by a technician. Depending on the pump being used and the pump level, the minimum speed may not be set too small, because the pump or the system may be damaged. The specifications from the affected manufacturer must be observed for this! When in doubt, the min. speed and the pump level should be set too high instead of too low.

Max. Speed

The maximum speed of the pump is determined here in %. During the setting, the pump runs in the respective speed and the flow can be determined.

 The specified percentages are variables, which may deviate more or less strongly depending on the system, pump and pump level. 100% is the maximum possible power of the controller.

Min. Speed

The minimum speed of the pump is determined here. During the setting, the pump runs in the respective speed and the flow can be determined.

 The specified percentages are variables, which may deviate more or less strongly depending on the system, pump and pump level. 100% is the maximum possible power of the controller.

Relay functions

Free, i.e. in the specific hydraulic variant unused relays, can be assigned to various additional functions. Every additional function can only be assigned once.

R1 to R4: mechanical relay 230V
V1 and V2: PWM and 0-10 V output

Please pay special attention to the relay's technical information (see "Specifications").

The symbols shown here are displayed on the main overview screen when the special function is activated.

 The sequence in this list does not correspond to the menu numbering in the controller.

Circulation



Depending on the temperature and time approval, a circulation pump is turned on for the DHW storage.

Circulation

Select signal output V2 and activate circulation.

Tmin

If this value at the circulation sensor is undershot and the circulation is approved the circulation pump is started.

Hysteresis

If the circulation Tmin value is exceeded by the value set here, the circulation pump will be shut down.

Circulations periods

Operating times of the circulation

Here the desired periods are set in which the circulation is approved. For each weekday, three times can be specified, furthermore, you can copy individual day to other days. The circulation is shut down outside of the set times.

AL-heating

With this function, a relay switches a boiler to anti-legionella mode as needed. The relay switches on when an anti-legionella heating starts. The relay switches off when the AL-heating was completed successfully or if the enable time for the AL-heating is exceeded. Activate or deactivate function.

Error Messages

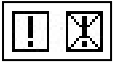

Select signal output V2 and activate error messages. If the burner request at signal output V1 is not used, this signal output can also be activated for the error message.

The signal output (V1/V2) is activated when one or more of the set protection functions are activated. This function can be inverted so that the signal output (V1/V2) is switched on (Always on) and then switched off when a protection function is activated.

Error message

Activate or deactivate function.

The additional function 'error message' switches the signal output (V1/V2) on at certain events and does not switch off again until the info message for the respective event has been read.

The following messages are available:

Sensor error

AL heating failed

Primary pump

Turns pump on when storage loading starts and off when storage loading ends.

Sludge purge

A valve is switched at variable intervals to drain sludge from the storage.

Interval

This setting defines how often the valve is opened.

Weekday

On this day the purging will take place.

Time

At this time the purging should start. (Only hour adjustable, no minutes)

Contin. Operation

The valve is opened for this time.

Primary Mixer

When this function is activated, water is mixed in the primary circuit by a mixer via the primary return. As a result, less energy is drawn from the storage tank at high storage tank temperatures, depending on the flow rate, since energy is mixed from the return flow.

Direction open=left

Direction of the mixing valve can be set here.

Turn Time

Length of turn time.

Pause Factor

Adjustment of mixer pause time.

burner



This function requests a burner when a request of a heating circuit or the DHW function is present. Depending on the request, the burner will turn on in a more economic manner in the Eco-Mode if the solar circulation pump is running.

Delay

Switch delay, valid for cooling and heat request. The burner first turns on after this time span if the switch conditions were reached and are still present. This feature prevents unnecessary switching by temperature fluctuations or gives time for a renewable energy source to generate energy.

Relay mode

Switching: Request is made via signal output V1.

Output signal to V1: "no request" = 0V, "request" = 10V

Modulating: Request is made via signal output V1. The SLC Plus outputs the requested temperature (calculated target VL) as a voltage via the signal output.

Example: Calculated target VL heating circuit 43 ° C, measured VL at sensor S2 40 ° C.

If the VL sensor exceeds the setpoint VL by 2K (preference/actual -) for more than 2 minutes, the SLC Plus requests a heat source with 4.3V (corresponds to 43 ° C setpoint VL).

The requested temperature can be raised with the value "Offset". 0.1 V correspond to 1 ° C. If you set an offset of 0.5 V, this results in a requested temperature of 48 ° C or 4.8 V (43 ° C corresponds to 4.3 V + 0.5 V (offset) = 4.8 V corresponds to 48 ° C)

Burner offset

When using the 0-10V outputs V1 for the burner function, the requested temperature is emitted through a corresponding voltage. This offset increases the requested temperature.

Parallel operation V1/V2

Switches the selected relay in parallel with the 0-10 V / PMW output V1/V2.

Switch parallel operation on, off or inverted.

Parallel operation

Here you can additionally set the switch mode.

On : The function switches parallel to the set signal output.

Inverted : The function switches contrary to the set signal output.

Delay

The assigned relay switches on the delay set here later than V1/V2.

Follow-up time

The assigned relay switched on for the time set here longer than V1/V2.

Always on



Relay is permanently switched on.

Signal V1/V2

The signal output V1 is factory-set for the burner request by 0-10V. Alternatively, the error message can also be selected and activated in the menu. Signal V2: The signal output V2 can be used to control a circulation pump or for error messages. To activate one of these functions, the corresponding menu item must be selected. The signal outputs V1/V2 (0-10V) can be used to switch higher voltages in conjunction with a potential-free relay (optional accessory). Only one function can be selected per signal output.

Pressure Monitoring

In this menu, the system pressure monitoring can be activated through a direct sensor. Once the set pressure conditions are exceeded, a message is generated and the LED flashes red.

Pressure Monitoring

A message is displayed and the LED flashes red when the pressure drops below minimum or exceeds the maximum.

Pmin

Minimum pressure. If this pressure is not met, the controller emits an error notification and the red LED flashes.

Pmax

Maximum pressure in the system. If this pressure is exceeded, the controller emits an error message and the red LED flashes.

Sensor Calibration

Deviations in the temperature values displayed, for example, due to cables which are too long or sensors which are not positioned optimally can be compensated for manually here. The settings can be made for each individual sensor in steps of 0.5 °C.

 Settings are only necessary in special cases at the time of initial commissioning by the specialist. Incorrect measurement values can lead to unpredictable errors.

Commissioning

Starting commissioning help guides you in the correct order through the basic settings necessary for commissioning, and provides brief descriptions of each parameter in the display. Pressing the ,esc' key takes you back to the previous value so you can look at the selected setting again or adjust it if desired. Pressing ,esc' more than once takes you back to the selection mode, thus cancelling the commissioning help (See "Commissioning help" on page 10).

 May only be started by a specialist during commissioning! Observe the explanations for the individual parameters in these instructions, and check whether further settings are necessary for your application.

Factory settings

All settings can be reset, returning the controller to its delivery state.

 All of the controller's parametrization, statistics, etc. will be lost irrevocably. The controller must then be commissioned once again.

Time & Date

Serve to set the current time and date.

 For time-dependent functions such as circulation and anti-legionella and the evaluation of system data, it is essential that the time is accurately set on the controller. Please note that the clock continues to run for about 24 hours if the mains voltage is interrupted, and afterward must be reset. Improper operation or an incorrect time may result in data being cleared, recorded incorrectly or overwritten. The manufacturer accepts no liability for the recorded data!

Daylight saving time

If this function is activated, the controller automatically changes to winter time or summer time (DST, Daylight Savings Time).

Eco Display Mode

In Eco Display Mode the backlight of the display is switched off if no buttons are pushed for 2 minutes.

 If a message exists, the backlight does not switch off until the message has been scanned by the user.

Temperature unit

In this menu you can select between the temperature units °C and °F.

Network

If necessary, the network settings of the connected data logger must be set.

Access Control

This menu lets you give up to 4 users access to the data logger. The users that are registered then have access to the controller or respectively the data logger.

To add a user in the list, select <add user>. Leave the now visible menu open und connect to the address of the connector or respectively the data logger. Your user name is going to appear in this menu and can be selected and confirmed with 'OK'.

Note

You can find the address of the connector or respectively the data logger on the address sticker on the outside of the casing. Pointers and help on how to establish a connection you can find in the enclosed SOREL Connect instructions or the instructions of the data logger.

Select a user with 'OK' to grant access.

To revoke access again, choose one of the users from your list and choose <remove user>.

Ethernet

The data logger's Ethernet connection settings can be set using this menu.

MAC Address

Displays the individual MAC address of the data logger.

Auto-Configuration (DHCP)

If auto-configuration is activated, the data logger requests IP addresses and network parameters from a DHCP server that assigns an IP address, subnet mask, gateway IP and DNS server IP. **If you deactivate the auto configuration (DHCP), you will have to make the required network settings manually!**

IP-Address

Please refer to the router configuration for the IP address to be set.

Subnet Mask

Please refer to the router configuration for the subnetz mask to be set.

Gateway

Please refer to the router configuration for the gateway to be set.

DNS-Server

Please refer to the router configuration for the DNS server to be set.

CAN bus ID

Here you can see the ID of the controller on the CAN bus.

Sensor send interval

The send interval determines how often the sensor and output values of the controller may be send via CAN. If a value changes, it is sent and starts the interval. The next values are not sent until the interval has expired. If no value changes, nothing is sent.

 If there are several controllers in the CAN network, a too short send interval can lead to an overload of the CAN network.

7. Menu Lock

Exit menu lock	
7.1.Menu lock	off
7.2.Expert mode	expert
▲	▼ Info

Secure the controller against unintentional changing and compromise of basic functions.

Menu lock active = "On"

Menu lock off = "Off"

In addition, the "Simple" menu view can be used to hide menu items that are not necessary for the daily use of the controller after commissioning. The menu item "Menu lock on/off" is also hidden when the "Simple" menu view is selected!

The menus listed below remain completely accessible despite the menu lock being activated, and can be used to make adjustments if necessary:

Measurement values

Statistic

Settings

Special Functions

Menu Lock

Language

8. Service Values

8.1.	SLC+
8.2.	2020/05/20.19107
8.3.P coeff.	4.000
▲	▼

Serve for remote diagnosis by a specialist or the manufacturer in the event of errors, etc.



Enter the values into the table when an error occurs.

9. Language

9.1.Deutsch		
9.2.English		
9.3.Shqip		
▲	▼	OK

To select the menu language. During initial commissioning and longer power interruptions, the query is made automatically.

Malfunctions/Maintenance

Replacing the Fuse

 Repairs and maintenance may only be performed by a specialist. Before working on the unit, switch off the power supply and secure it against being switched on again! Check that there is no power flowing!

 Only use the supplied spare fuse or a fuse of the same design with the following specifications: 2 AT/250 V.



If the mains voltage is switched on and the controller still does not function or display anything, then the internal device fuse may be defective. First find the external fault source (e.g. pump), replace it and then check the device fuse.

To replace the device fuse, open the device as described under "See "Wall Installation" on page 8", remove the old fuse, check it and replace if necessary.

Then first recommission the controller and check the function of the switch outputs in manual mode as described in Section 3.2.. .

Maintenance

 In the course of the general annual maintenance of your heating system, the functions of the controller should also be checked by a specialist and the settings should be optimized if necessary.

Performing maintenance:

- Check the date and time See "Time & Date" on page 19
- Assess/check plausibility of statistics See "Statistics" on page 11
- Check the error memory See "Message Log" on page 11
- Verify/check plausibility of the current measurement values See "Measurement values" on page 11
- Check the switch outputs/consumers in manual mode See "Manual" on page 12
- Possible optimization of the parameters setting (**only on customers request**)

Possible error messages

Possible error messages	Notes for the specialist
Sensor x defective	Means that either the sensor, sensor entrance on the controller or the connecting wire was defective (See "Temperature Resistance Table for Pt1000 Sensors" on page 9).
Restart	Means that the controller was restarted, for example, due to a power outage. Check date & time!
Time & Date	This display appears automatically after a longer network disruption, because the time & date must be examined and, if applicable, adjusted.
Frequent on / off	A relay was switched on and off more than 5 times within 5 minutes.
AL failed	Anti-legionella failed appears if at least anti-legionella $T_{soll} -5^{\circ}\text{C}$ could not be held at the anti-legionella sensor for the set exposure time.

Tips

 The service values include not only current measurement values and operating states, but also all of the settings for the controller. Write the service values down just once after commissioning has been successfully completed.

 In the event of uncertainty as to the control response or malfunctions the service values are a proven and successful method for remote diagnosis. Write the service values down at the time that the suspected malfunction occurs. Send the service value table by fax or e-mail with a brief description of the error to the specialist or manufacturer.

 To protect against loss of data, record any statistics and data of particular importance at regular intervals.

Final Declaration

Although these instructions have been created with the greatest possible care, the possibility of incorrect or incomplete information cannot be excluded. Subject as a basic principle to errors and technical changes.

Date and time of installation:

Name of installation company:

Space for notes:

Your specialist dealer:

Manufacturer:

SOREL GmbH Mikroelektronik
Reme-Str. 12
D - 58300 Wetter (Ruhr)

+49 (0)2335 682 77 0
+49 (0)2335 682 77 10

info@sorel.de
www.sorel.de

Version: 21.07.2022
SOREL